

HOW TO INSTALL HORIZONTAL BLINDS

Congratulations on your purchase of a horizontal mini blind. Your mini blind has been custom made to your specifications and is one of the finest window treatments available. Before you unwrap your blinds, please take a few moments to read these instructions. With careful installation and periodic cleaning, your mini blinds will provide you with many years of trouble free service.

Parts List:

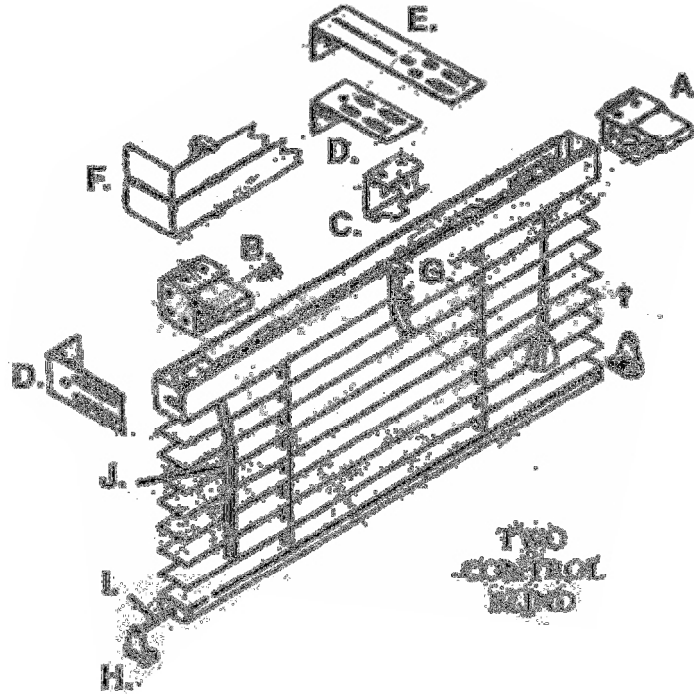

Note: All parts listed are not included with every blind.

- | | |
|--|----------------------------------|
| A. Right hand end bracket | F. Standard or deluxe valance |
| B. Left hand end bracket | G. Valance clip |
| C. Center support bracket | H. Hold down bracket with screws |
| D. Short Extension bracket (<i>optional</i>) | I. Hold down pin |
| E. Long Extension bracket (<i>optional</i>) | J. Wand |

Tools Needed:

- Tape measure (*metal or wood*)
- Pencil
- Level(*optional*)
- Screwdriver
- Drill
- 1/16" or 3/32" Drill Bit

CAUTION: Use proper screws. The mounting screws included are for wood or sheet metal surfaces. For other surfaces, obtain appropriate fasteners and install them according to the manufacturer's instructions.

1. INSTALLATION INSTRUCTIONS

Your blind was made to be installed as either an inside or outside mount. Follow the instructions that apply to your blind.

INSIDE MOUNT

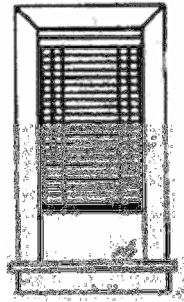

OUTSIDE MOUNT

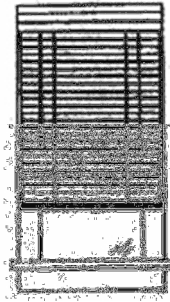

Unpack your new blind and check the packing carefully to assure all parts have been removed before discarding the shipping container.

For an Outside mount, hold the blind level and centered against the window casing. Mark the casing with a pencil just below the headrail on each end. Also mark the window casing $1/8$ " beyond the ends of the headrail. The right and left installation brackets will be placed on these marks.

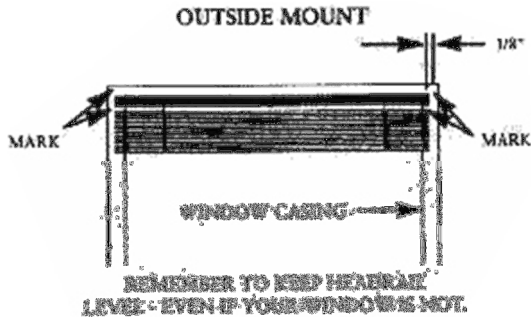

For an Inside Mount, make sure the headrail is level and clear of obstructions. Make pencil marks below the headrail on each end. The right hand and left hand installation brackets will be placed on these marks.

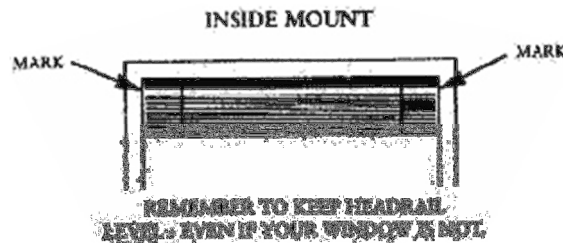

For ceiling or Overhead Mount, hold the blind against the ceiling centered in front of the window and make pencil marks $1/8$ " beyond the ends of the headrail. The right and left installation brackets will be placed on these marks.

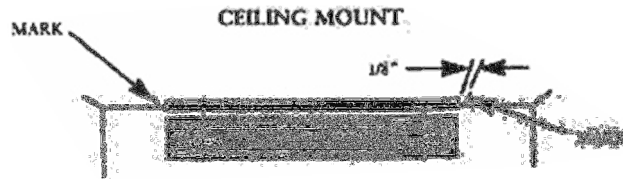

The end brackets may be mounted using two screws in several different orientations depending on your needs:

- A. Inside the jambs (*inside mount*)
- B. To the outside face of the window casing or wall (*outside mount*)
- C. Overhead; either to the top inside of the window frame (*inside mount*) or to the ceiling (*outside mount*).

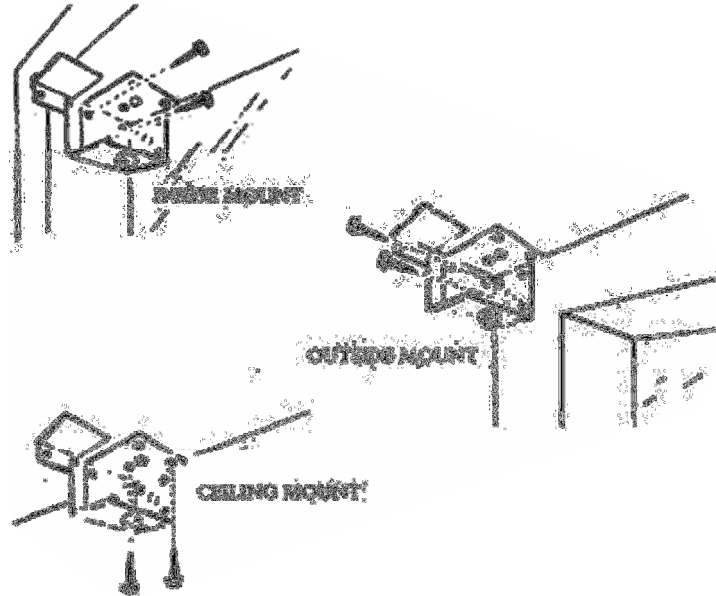

Use proper screws. Two screws are supplied for each mounting bracket. These are suitable for most wood and sheet metal surfaces. On wood surfaces pre-drill holes for the screws using a 1/16" drill bit or make a starter hole with a finishing nail and hammer or awl. On sheet metal surfaces use a 3/32" steel drill bit. For plaster, drywall, concrete, stone, brick or tile use appropriate plugs, anchors or screws of the proper type and length. Follow the manufacturers recommendations.

Open the brackets swivel cover with a screwdriver. Hold the brackets against the mounting surface and align it with the pencil marks. Using a pencil, mark the location of two diagonal holes for the mounting screws. Drill holes for the screws using one of the recommended drill bits. If working on a wood surface, locate the screws at least 1/4" from the edge of the wood to prevent splitting.

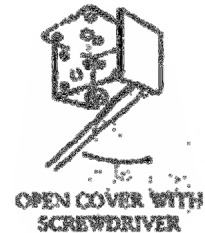

Hint: Smearing a little bar soap on the screw treads will make them drive more easily and help protect the wood from splitting.

Center support brackets are supplied if required. Space multiple brackets evenly along headrail.

Center support brackets must be positioned so that they do not interfere with the operation of the blind cord and ladders. Mount center support brackets level with the end brackets

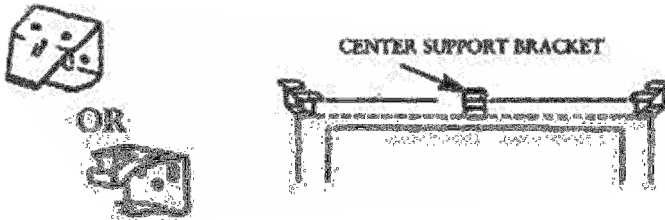

Snap the valance clips over the headrail before mounting the blind to the installation brackets. A valance clip is furnished for every ladder. Install the valance clip next to each ladder. If the clips are mounted directly in line with the ladders, they may catch the cords inside the headrail.

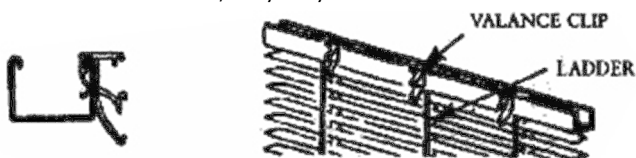

Insert the headrail into the end brackets. If an auxiliary support bracket is used, Be sure that it is properly engaged with the headrail.



Close the swivel covers to lock the headrail in place



If your blind is not fitting snugly left to right, open the mounting brackets, remove the headrail and pry out the tab(s) at the ends of the headrail a bit with a screwdriver.



If your blind fits too tightly, press the tab(s) in with a pair of pliers. Now reinstall the headrail and close the mounting bracket covers.

Optional Projection Brackets

If you ordered the optional projection brackets, mount them to the wall or window using two screws. Attach the installation and center brackets using two machine screws and nuts per bracket.

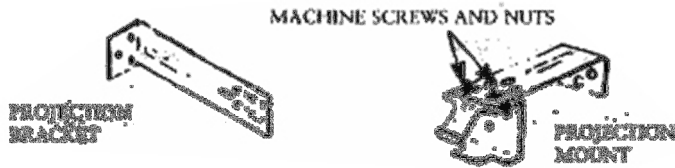

2. VALANCE INSTALLATION

Deluxe Valances with valance Channel (optional)

On outside mount blinds, the valance channel is notched or pre-formed on the backside to allow the ends of the channel to be formed into returns. Bend ends back to form returns.

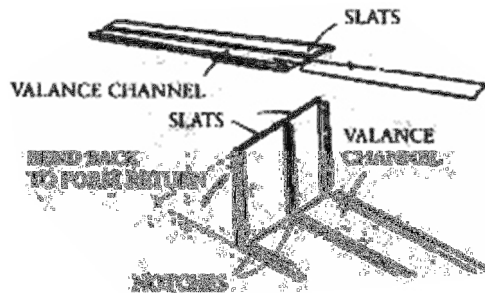

Starting at one end, place the upper lip of the valance into the top groove of the valance bracket. Carefully snap the lower lip into the bottom groove on the bracket. Repeat this at each bracket. Valance return length may be trimmed with scissors if necessary.

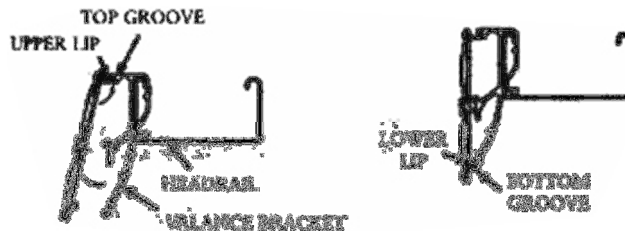

Standard Valances Without Valance Channel

Place the lower edge of the slat into the center groove in the valance bracket. Now Carefully snap the upper edge of the slat into the top groove in the bracket. Repeat this at each bracket across the blind. The Lower valance slat is installed in the same manner by placing its lower edge into the lower groove in the valance bracket and carefully snapping the upper edge into the center groove of the bracket. The slats may be trimmed with scissors if necessary.

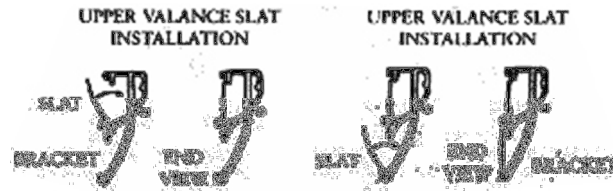

To bend the returns, place the slats on a table with the concave (*back*) side up. Measure and mark the return size on each end of the slat. Place a ruler (*or other straight edge*) on the mark and hold it firmly in place with one hand. Place the other hand under the slat and bend it straight up.

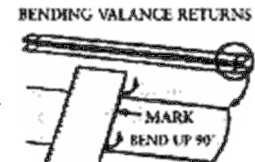

Install the valance slats as previously described.

3. HOLD DOWN BRACKETS (*Optional*)

Note:Not recommended for single control blinds.

Hold down brackets are used to keep the bottom of the blind from swaying and were supplied if requested when ordering the blind. Some blinds have bottomrail end caps with a hold in the center; on these blinds, push a hold down pin into the hole in the end caps.

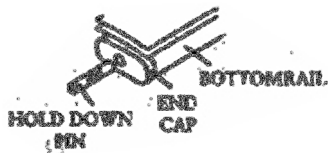

- Lower blind completely. Be sure bottomrail is level.
- Place hold down brackets on bottomrail hold down pins (*slotted bracket on the right, slot down*). Mark bracket location on window frame.
- Remove brackets and raise blind.
- Drill holes for bracket screws and mount brackets.
- To secure bottomrail, insert hold down pin into unslotted bracket first. Then, snap opposite pin into slotted bracket.

4. OPERATING A BLIND WITH TWO CONTROLS

Tilt: Turn wand to tilt slats to desired angle.

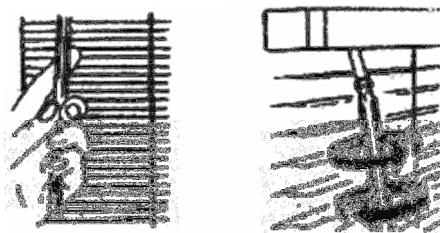

Raise Or Lower:Slats should be fully open, not tilted, when raising or lowering. To raise blind, pull lift cord straight down. To lower blind, pull cord toward center of blind and slowly raise your hand while holding on to the cord.

Lock: When cord hangs straight down, the cord lock holds blind in position.

Caution: When blind is raised, **Keep Lift Cords Away From Door Openings** to prevent tripping hazard.

5. CLEANING

We recommend routine dusting with a soft brush, cloth or clean them with a vacuum cleaner's brush attachment. If blinds become soiled, They may be cleaned with a soft cloth dampened with warm water. You may want to add a small amount of mild, non-abrasive liquid soap (*ie. Dove, Ivory, ect.*) to the warm water. It is also possible to have your blind professionally cleaned. We advise you to utilize professional window treatment cleaning services if you elect to have your blinds cleaned by methods other than those suggested above. Our warranty does not cover damages caused by cleaning service.

WARNING

To avoid possible strangulation keep cords out of reach of children.
Use these devices:

1. Clamp or clothes pin
2. Cleat
3. Tie the cord to itself
4. Tie-down devices